



OWNER'S MANUAL

GRACIOSO 2.0 ST (STANDARD)

HIGH DEFINITION
2-WAY/DOWN FIRE BASS REFLEX
LOUDSPEAKERS



ACOUSTIC PREFERENCE D.O.O.
HANDCRAFTED IN SLOVENIA-EU

-WARNING-

TO REDUCE RISK OF FIRE OR ELECTRICAL SHOCK, DO NOT EXPOSE THIS EQUIPEMENT TO RAIN OR MOISTURE.

CAUTION!

NO USER-SERVICEABLE PARTS INSIDE. DO NOT REMOVE DRIVERS OR BACK TERMINALS. REFER SERVICING TO QUALIFIED PERSONNEL.

Changes or modifications of this loudspeakers will void the warranty.

IMPORTANT SAFETY INSTRUCTIONS!

PLEASE READ BEFORE OPERATING THIS EQUIPMENT:

1. Read these instructions.
2. Keep these instructions.
3. Heed all warnings.
4. Follow all instructions.
5. Do not expose this apparatus to dripping or splashing and ensure that no object filled with liquids, such as vases, are placed on the apparatus.
6. Do not install near any heat source such as radiators, heat registers, stoves, or other apparatus (including amplifiers) that produce heat. Never expose this product to extremely high or low temperatures.
7. Clean wooden surfaces only with a dry cloth and specialty wood cleaners.
8. Do not touch the membrane of the speaker drivers.
9. Connect unit in accordance with the manufacturer's instructions.
10. Protect the loudspeakers chord from being stepped on or pinched, particularly near the plug and at the point where they exit from the unit.
11. Servicing by qualified personnel is required when the unit has been damaged in any way.
12. This apparatus is capable of producing high sound pressure levels. Continued exposure to high sound pressure levels can cause permanent hearing impairment or loss. User caution is advised and ear protection is recommended when playing at high volumes.
13. Always keep electrical equipment out of the reach of children.

Table of contents:

1. ABOUT GRACIOSO 2.0 ST	page 3
2. TECHNICAL SPECIFICATION	page 3
3. HANDLING	page 4
4. PLACEMENT	page 6
5. CONNECTIONS	page 6-8
6. USING	page 8
7. ACOUSTIC PREFERENCE LIMITED WARRANTY	page 9
8. SECURITY	page 10

1. ABOUT GRACIOSO 2.0 ST (Standard version)

The Gracioso 2.0 ST is a 2-way, down fire bass reflex loudspeaker, distinctive by its topmost design and dramatically realistic sound. Because of its power-handling and sensitivity, it is suitable for most audio systems. It will fit in midsize to large rooms, sonically and visually. Each Gracioso 2.0 ST speaker is a unique and exclusively handmade product. Every pair is inspected, matched, tested and approved in Acoustic Preference labs before being sent to the customer.

Each pair of Gracioso 2.0 ST (Standard) has a declaration of the handmade manufacturing.

2. TECHNICAL SPECIFICATION

Loudspeakers specification:

- 2-way/bass reflex system (down fire)
- 12 dB/oct/LKR/2800 Hz crossover
- Frequency response: 37 Hz - 35 kHz
- Sensitivity: 89 dB / 1W/ 1m
- Power/Impedance: 150 W / 8 Ohm
- Dimensions: 255 (315) x 355 (420) x 1050 mm (W x D x H) with spikes
- Weight: approx. 27.0 kg/unit; approx. 2 x 48 kg with wooden crates.

Cabinet

- Prestigious walnut wood - integral construction system
- Min.4 layers hand waxed - natural wax oil
- Dispersed "down fire" bass reflex system
- Magnet grill holder system
- Soundcare flat feet

Mid-bass section (Special high grade from MOREL)

- Dimension 160mm (6.3")
- Transient Power 10ms 1000W
- Nominal Power Handling (DIN) P 150W
- Uniflow™ Aluminum diecast chassis
- High flux ferrite double magnet system
- 3" Large Hexatech™ Aluminum voice coil

- High power handling
- Shallow profile D.P.C cone
- Cone Material Damped Polymer Composite
- Improved parameters

Tweeter (Special high grade from SCANSPEAK)

- 26 mm (1") Ring Dome Diaphragm
- Patented Symmetrical Drive (SD-2) motor
- Diffraction Damping Rubber Front
- Patented Phase Plug Design
- AirCirc Motor Design w. 6 Neo magnets
- Die Cast Rubber Painted Alu Face Plate

Crossover

- 12 dB/oct/LKR/2800 Hz crossover
- Mundorf Air Foil Coils, 99.99% pure OFC copper with Polypropylene insulation.
- Mundorf High-End Audio Grade MKP capacitors.
- High quality Rhodium Bi-wire terminals
- Point-to-point construction with UP-OCC Copper/teflon internal wiring
- Circuit boards base from hard wood plates in suitable thickness

3. HANDLING

After removing the external covering of packing, grasp the straps to lift the loudspeaker out of the packing box. Follow all the enclosed instructions for setting up the loudspeakers.

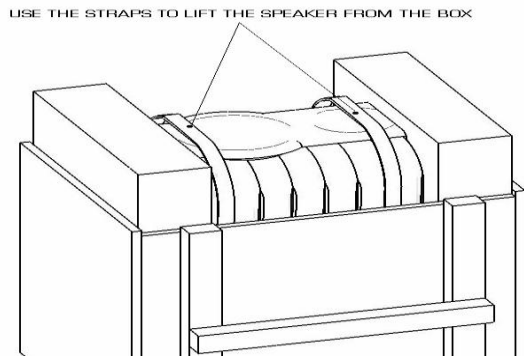

Figure 1: After removing the external covering of packing, grasp the straps to lift the loudspeaker out of the wooden crates.

PROTECTIVE GRILLS:

Protective grills are attached to the speakers with a self-centering magnet system. You can remove them by gently pulling them away from the speakers. They can be re-attached by bringing them near to their position on the speaker and the magnets will lock the grills into the right position.

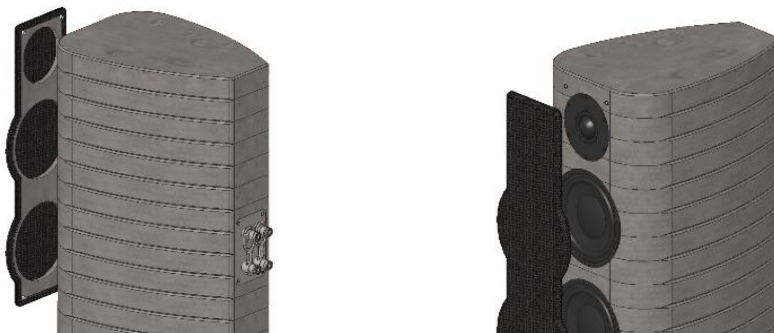

Figure 2: Protective grills are attached to the speakers with a self-centering magnet system.

FEET:

Firmly mount the feet into the black aluminum sockets in the bottom of the speaker. Feet are height adjustable and allow levelling of the speaker in the case of uneven floors.

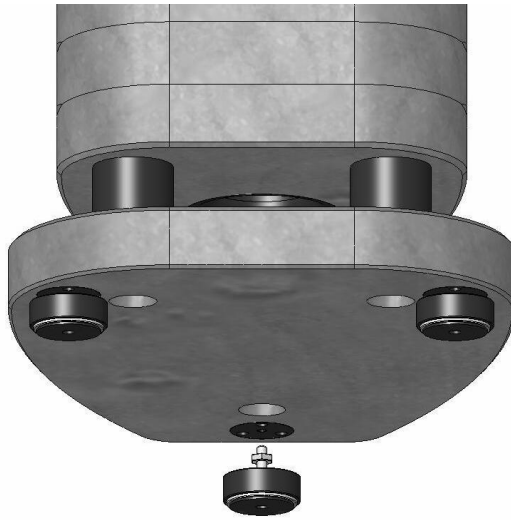

Figure 3 : Firmly mount the feet into the black aluminum sockets in the bottom of the speaker.

TERMINAL BRIDGES:

Remove terminal jumpers/bridges if using bi-wire connection.



Figure 4: Remove terminal jumpers/bridges if using bi-wire connection.

4. PLACEMENT

All loudspeakers interact with the environment in which they are placed. Loudspeaker performance is influenced by the size, shape, and contents of the listening room as well as the placement of the loudspeaker within the room. The distance between the speakers and the rear wall should, ideally, be between a half and a full meter. (For the best stereo imaging and a sense of spaciousness, place the speakers at equal distances from the primary listening position and the side walls; move speakers closer to the corners or walls of the listening room to increase bass response).

Remove all obstructions between speakers and the primary listening position. For instance, a coffee table between a speaker and the primary listening position will degrade stereo imaging and timbre. Placing a speaker near large objects may also cause unwanted reflections.

In home theatre systems, the magnetic radiation of the loudspeakers must be taken into consideration. It is strongly advised to refrain from placing front loudspeakers closer than 50cm from your TV. The distance between the speakers should be slightly less than the distance from the speakers to the listening area. For the best stereo imaging and sound staging, the listener should be equidistant from the 2 speakers. The angle at which the speakers are aimed at the listener will vary from room to room. We recommend the following two alternatives:

- 1) Position the loudspeakers parallel to the rear wall (widen the soundstage).
- 2) Toe the loudspeakers in to aim at the listening area (optimal stereo imaging and timbre). Experimentation is vitally important to achieve optimum results in any given environment.

5. CONNECTIONS

Turn off all audio system power before making any connections. Use high-quality loudspeaker cables. The length and type of speaker cable used for your system will have an audible effect. Make all connections observing the proper polarity, positive-to-positive (+) and negative-to-negative (-). Most speaker cables are marked so that it is possible to distinguish between conductors by the color of the insulation or by a white stripe or small raised edge along one conductor. Correct phasing of the speakers is vital for sound quality.

Connecting your Gracioso loudspeakers

1. Connect one pair of loudspeaker wires to the input connectors. Then connect the same pair of loudspeaker wires to the desired power amplifier output channel.
2. Repeat step 1 to connect the second loudspeaker to a separate power amplifier output channel.
3. In next pages you will find instruction for different amplifiers modes.

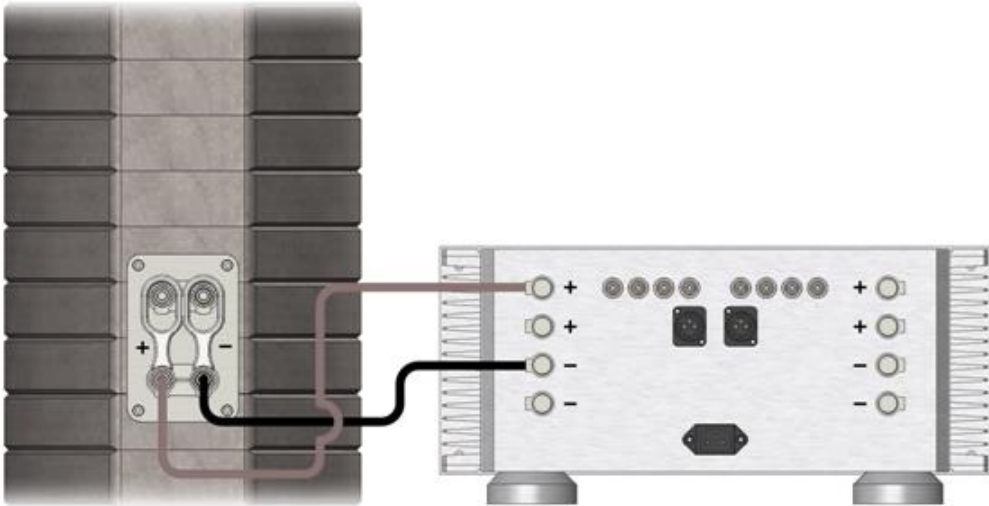

Figure 5: Connection with single stereo amplifier. Use jumpers/bridges.

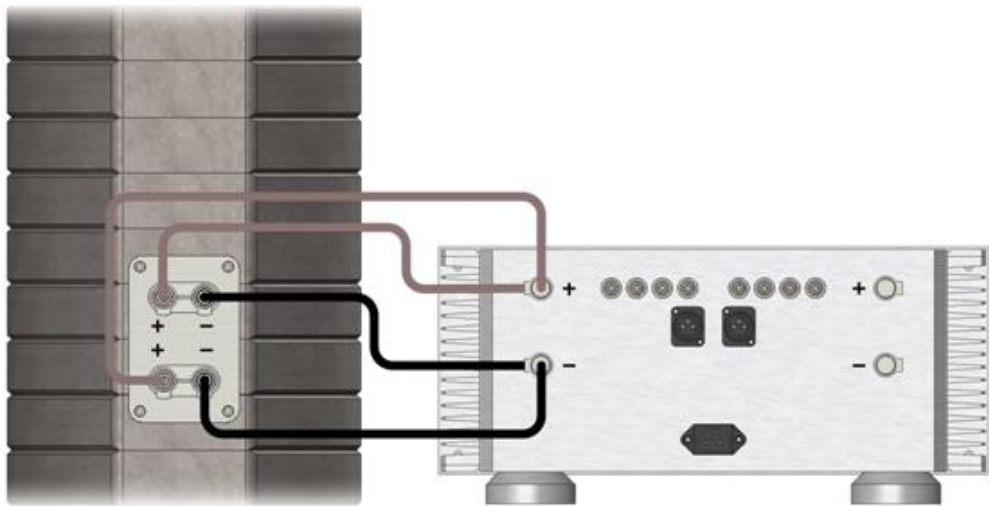

Figure 6.1: Bi-wire connection with single stereo amplifier. Remove jumpers-bridges.

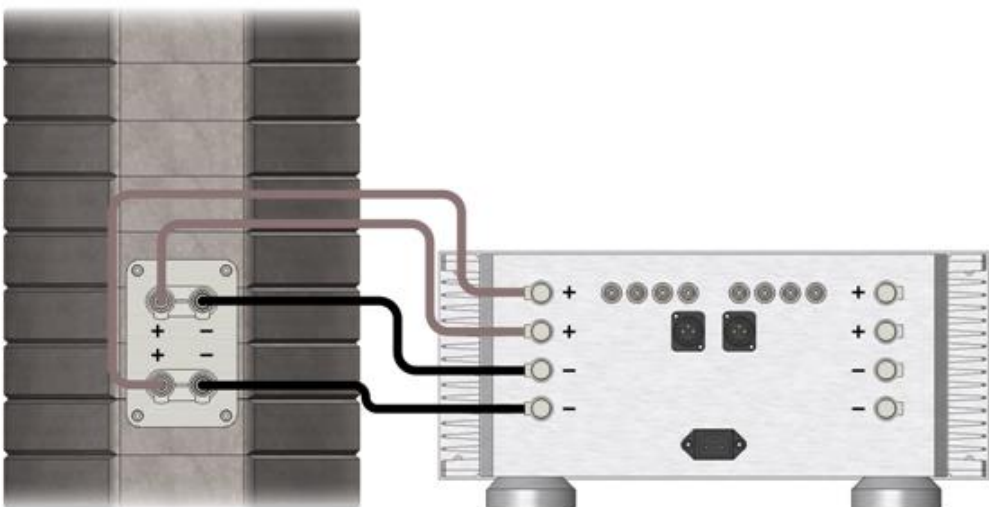

Figure 6.2: Bi-wire connection with single stereo amplifier. Remove jumpers-bridges.

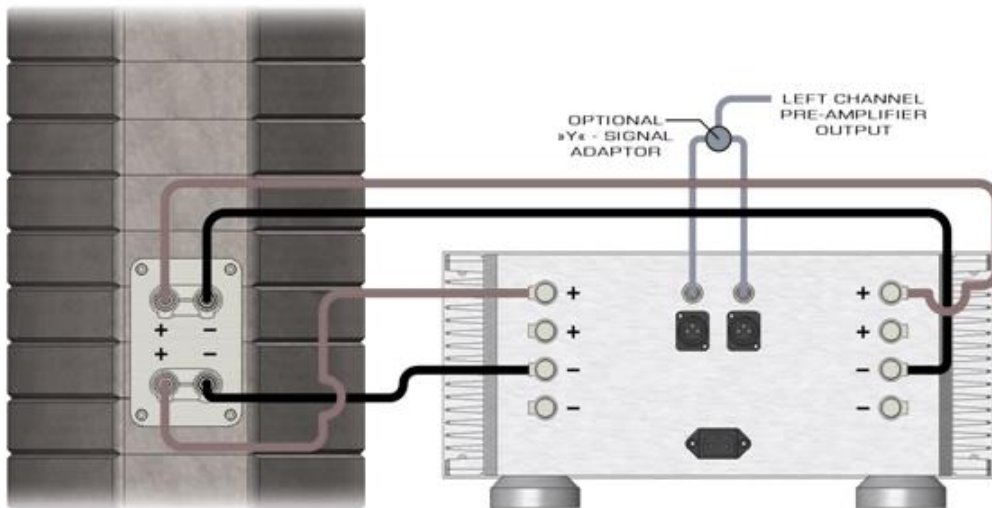

Figure 7: Bi-amp with single stereo amplifier. Remove jumpers-bridges.

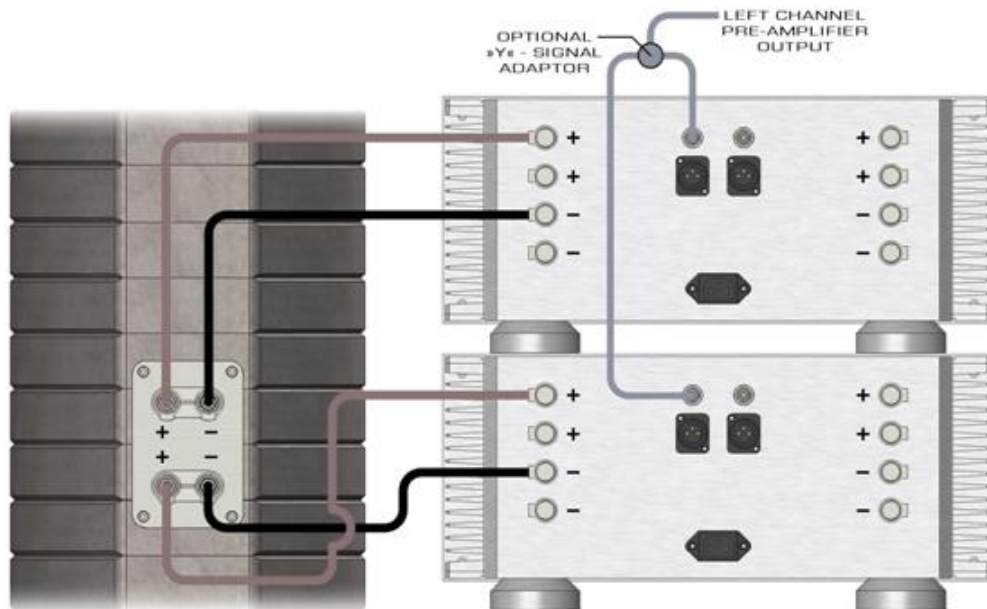

Figure 8: Bi-amp with two stereo amplifiers. Remove jumpers-bridges.

6. USING

- After the correct installation and connection of the speakers, first check the settings of your audio amplifier/receiver.
- Never use unprotected/uninsulated jumpers/bridges for connecting the +/+ or -/- connectors, as this may cause a short circuit.
- Never insert metallic or conductive objects in connectors for cables.
- Before use, always check if specification of audio amplifier/receiver meets the requirements of the loudspeakers (Power, Impedance, Voltage etc.).
- Make sure that audio amplifier/receiver is initially set to minimum volume and gradually increase to desired volume.

- New loudspeakers should NEVER be exposed to high volume initially, since electronic and mechanical components must burn-in gradually.
- Never exceed the listening volume which could cause uncomfortable feeling or ear damage.
- Never exceed the listening volume which would cause excessive vibrations or distorted sound through the speakers.
- Always disconnect loudspeakers cable on the AMPLIFIER side first, as it may otherwise cause a short circuit on amplifier outputs.
- Before disconnecting cables always turn off the receiver/amplifier or disconnect it from the electricity.
- Listening should be a pleasure, so always use the volume settings that will suit you.

7. ACOUSTIC PREFERENCE LIMITED WARRANTY

Acoustic Preference products are manufactured from the highest quality materials and components selected with maximum care. State-of-the-art technical and design solutions are also taken into account. Acoustic Preference products are extensively tested with lots of care and precision and must pass rigorous quality control standards to ensure first-class service and delights to all customers.

Acoustic Preference loudspeakers, that not meet your expectations, may be returned to the factory with a full money-back guarantee within 45 days of purchase provided if loudspeakers was purchased directly from Acoustic Preference (if returned, customer is responsible for shipping charges).

Loudspeakers must be returned undamaged, in their original packaging with all documentation and accessories. If the customer does not return them in that state, the manufacturer may refuse to refund without explanation.

An Acoustic Preference warranty protects the first owner (parts and labor), for a period of five (5) years starting from the date of purchase, from any failure resulting from manufacturing defects.

A valid International warranty card or original Invoice with serial number is required for warranty coverage. 5 years of warranty is valid for first owner only. All new customers must register new ownership at the dealer or manufacturer with original invoice. Rest of 5 years warranty is transferable to subsequent purchasers. Limited 5 years warranty starts with day of purchase at dealer or manufacturer.

NOTICE: For Ex-Demo or exhibition models, dealer or distributor can reduce warranty without manufacturer permission!

TERMS AND CONDITIONS

1. This warranty is only valid in the case of manufacturers defects (materials and/or workmanship) from the time of purchase of first owner (Limited warranty).
2. Warranty will not be accepted:
 - for damages caused by any use other than correct use described in the user manual,
 - for damages on drivers or electronic, if amplifier with power over 150W per channel will be used,
 - If product is used in unsuitable room, excessive humidity or temperature, exposure to gas, UV light and others,
 - if apply pressure to the diaphragm speaker, as this may cause irreparable damage,
 - for damages caused by incorrect installation, connection or packing,

MANUALS GRACIOSO 2.0 ST

- for negligence, modifications, or use of parts that are not made or authorized by Acoustic Preference,
- for damages caused by faulty or unsuitable auxiliary equipment,
- for damages caused by accidents, lightning, water, fire heat, war, public disturbances or any other cause beyond the reasonable control of Acoustic Preference,
- for products whose serial number has been altered, deleted, removed or made illegible,
- In cases that repairs or modifications have been executed by an unauthorized person.
- If the product is used contrary to the manufacturer's instructions.

3. Return:

Return authorization must first be obtained by either calling or writing to Acoustic Preference customer support prior to shipping the product. When obtaining return authorization, please be prepared to provide the model, serial number, and a complete, explicit description of the problem. A copy of the original, dated Bill of Sale must be included to confirm warranty status.

4. Shipping and Transfer of Risk:

The customer is responsible for shipping and insurance. The risk is transferred to the buyer as soon as the shipment has been taken over by the forwarder/forwarding agent or has left the seller's warehouse for shipment. If shipment is delayed on request of the buyer, the risk is transferred to the buyer at the time of shipping notice. Please always retain the original packing materials. Acoustic Preference products must be properly packed (in their original packing materials whenever possible) and the proper return authorization must be visible on the outer carton for easy identification. Improper packaging may lead to unnecessary freight damage that is not covered by either the freight carrier or the warranty.

8. SECURITY

Acoustic Preference knows that you care how information about you is used and shared. We appreciate your trust in us, and we assure that your personal information will be handled with utmost care and in accordance with EU personal data protection acts.

Thank you for choosing Gracioso line loudspeakers.

*We wish you **timeless experience** with **finest audio** loudspeakers.*

Your Acoustic Preference Team

MANUALS GRACIOSO 2.0 ST

HANDCRAFTED BY ACOUSTIC PREFERENCE D.O.O.

TIMELESS EXPERIENCE, FINEST AUDIO



THESE LOUDSPEAKERS HAVE BEEN CREATED WITH GREAT JOY AND KNOWLEDGE, TO TAKE YOU TO UNIQUE ENJOYMENT IN MUSIC.

ACOUSTIC PREFERENCE D.O.O.

ADAMICEVA 41, 2000 MARIBOR, SLOVENIA-EU

WWW.ACOUSTIC-PREFERENCE.COM

E-MAIL: INFO@ACOUSTIC-PREFERENCE.COM; PHONE: +38624297146

